

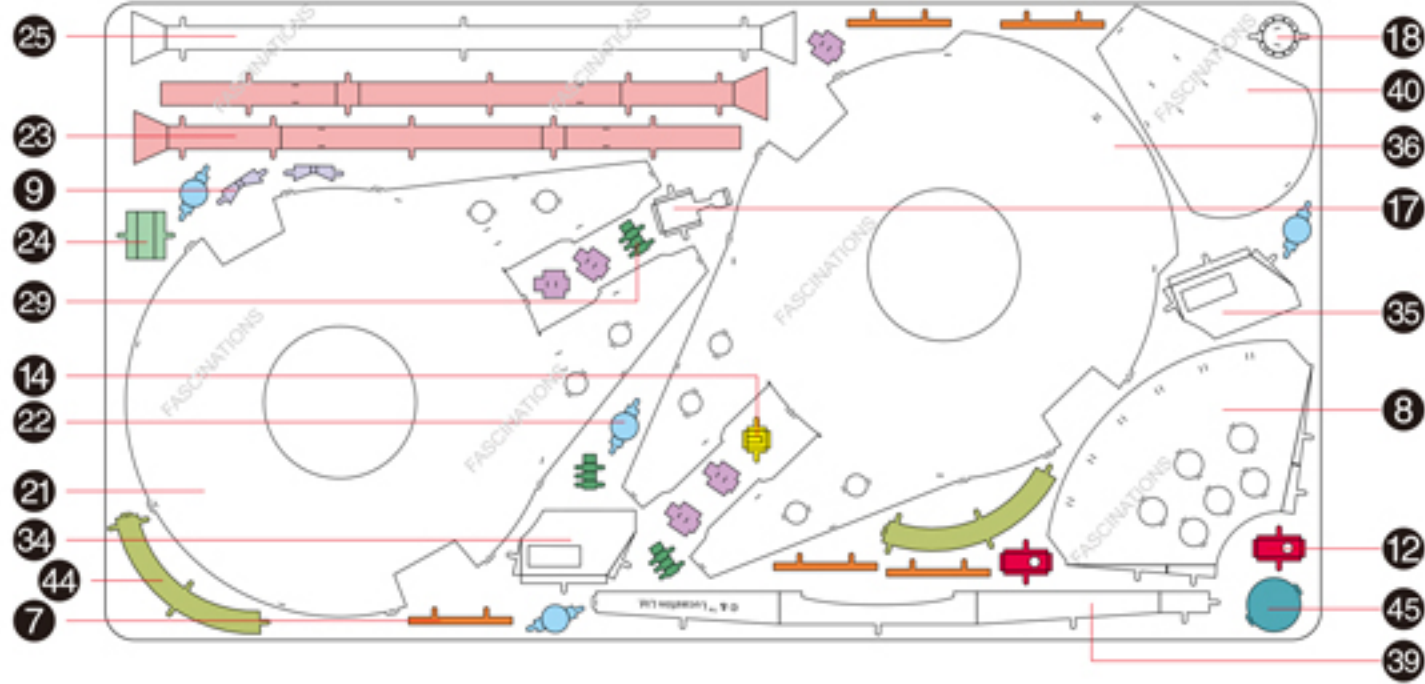

It is highly recommended that you visit www.metalearth.com/360/icx200b to see the completed model before assembling your own

3D METAL MODEL KITS

METAL SHEET 1



METAL SHEET 2

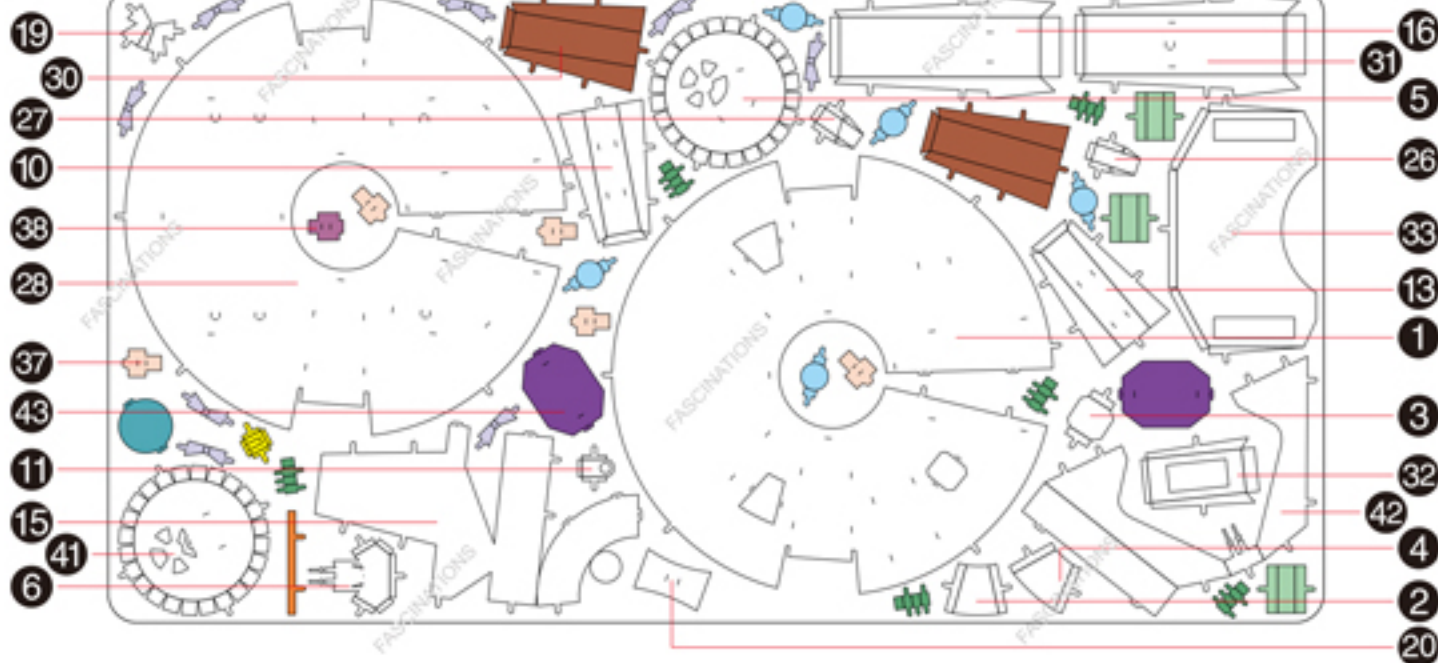

In order to avoid possible injury from sharp edges, please carefully discard the metal sheet after parts have been removed.

ICX200B

Millennium Falcon

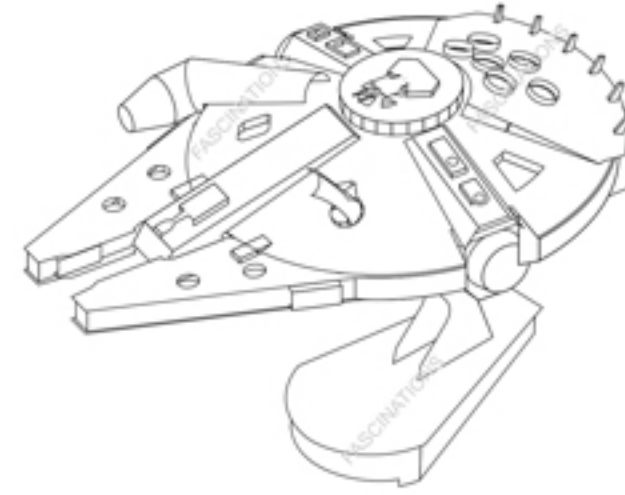

TO CREATE THE BEST CONNECTIONS

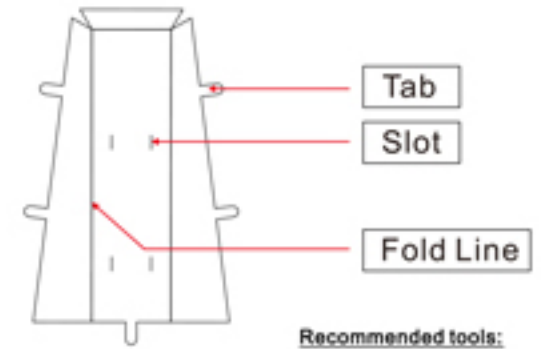

Legends:

- Engraved side
- Non-engraved side
- Attention point
- Insert tab and bend 90 degrees
- Insert tab and twist 90 degrees

Recommended tools:

-Wire cutters: helpful for taking parts from the metal sheets.



-Tweezers or needle nose pliers: helpful for folding parts, bending and twisting tabs.



Assembly tip:

If needed, slightly twist tabs to hold parts together then untwist and bend them down for a nice finish

ASSEMBLY STEPS

Step 1

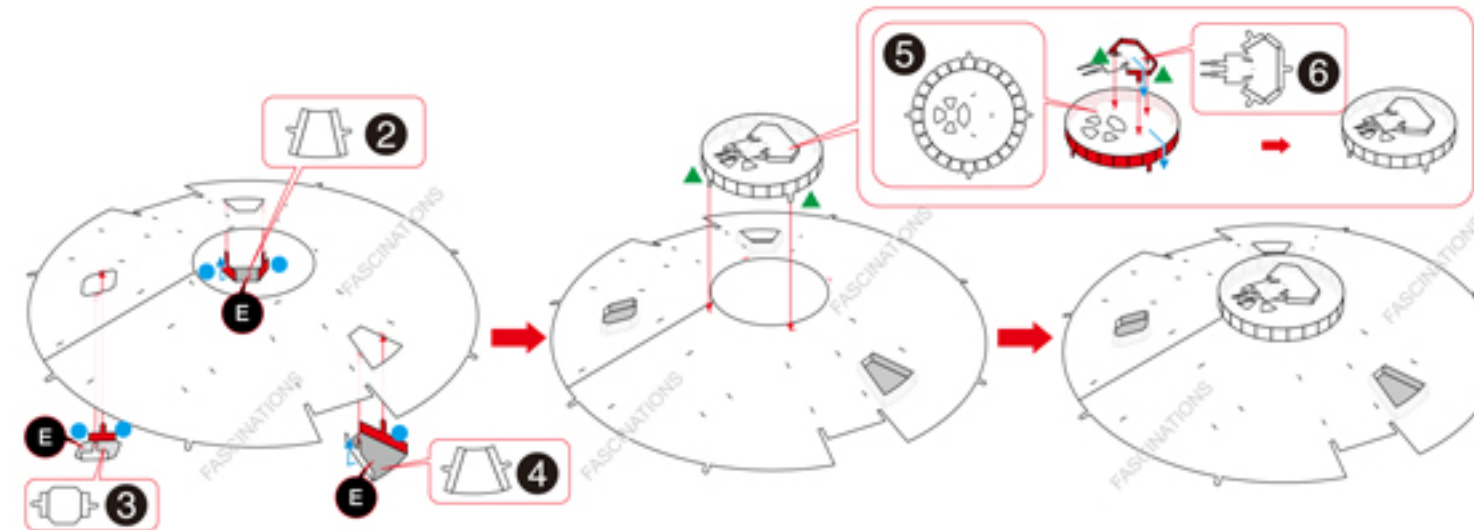
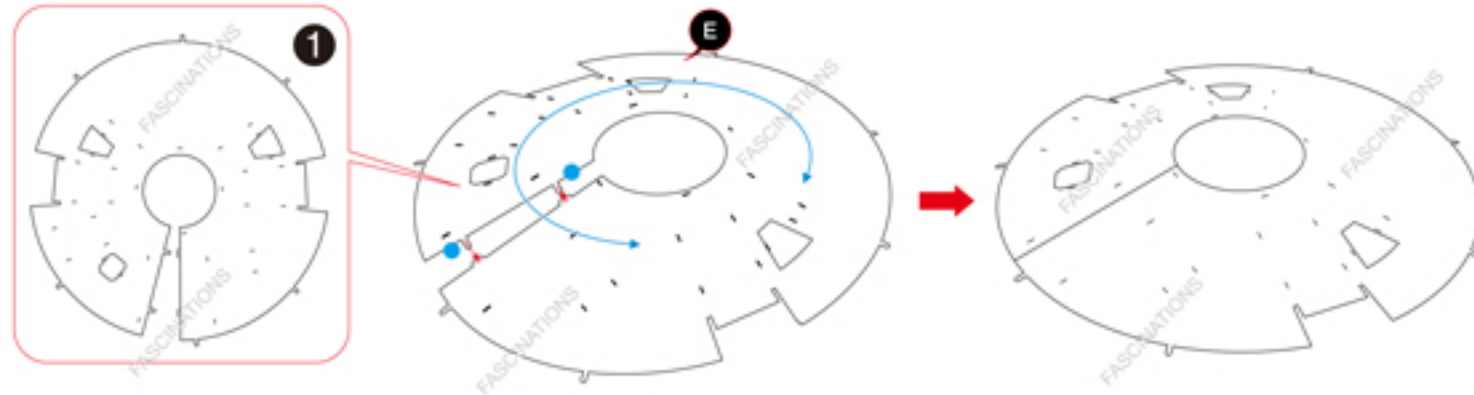

Step 2

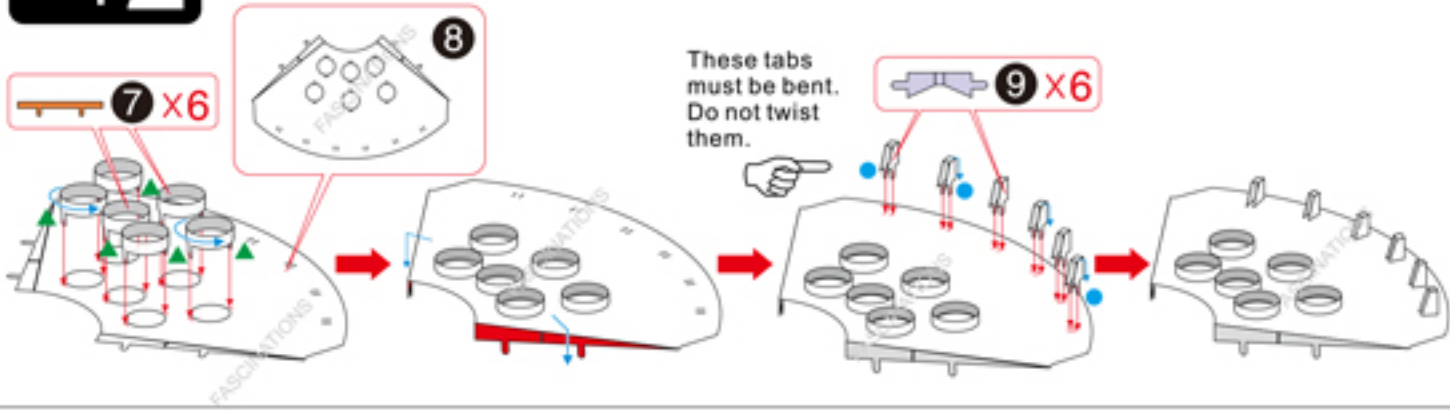

Step 3

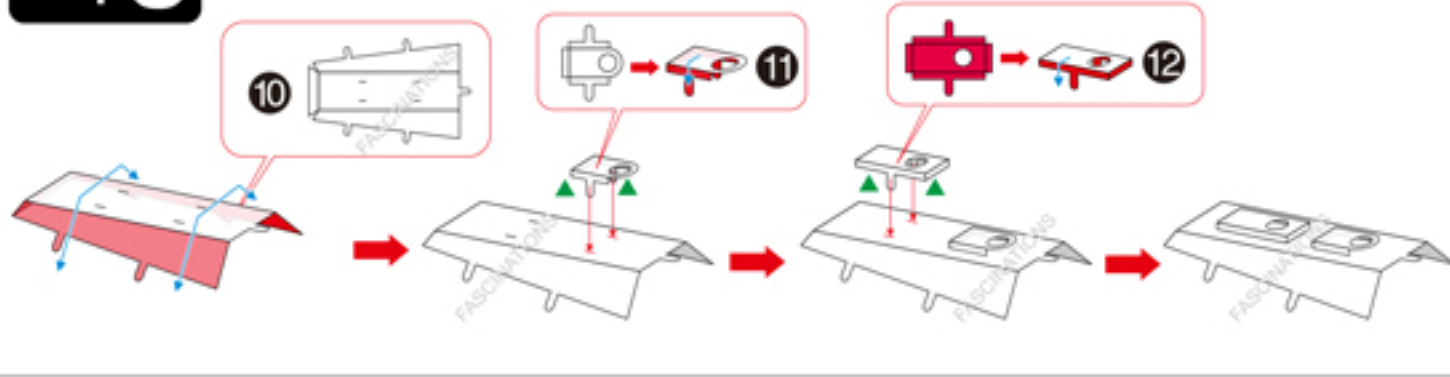

Step 4

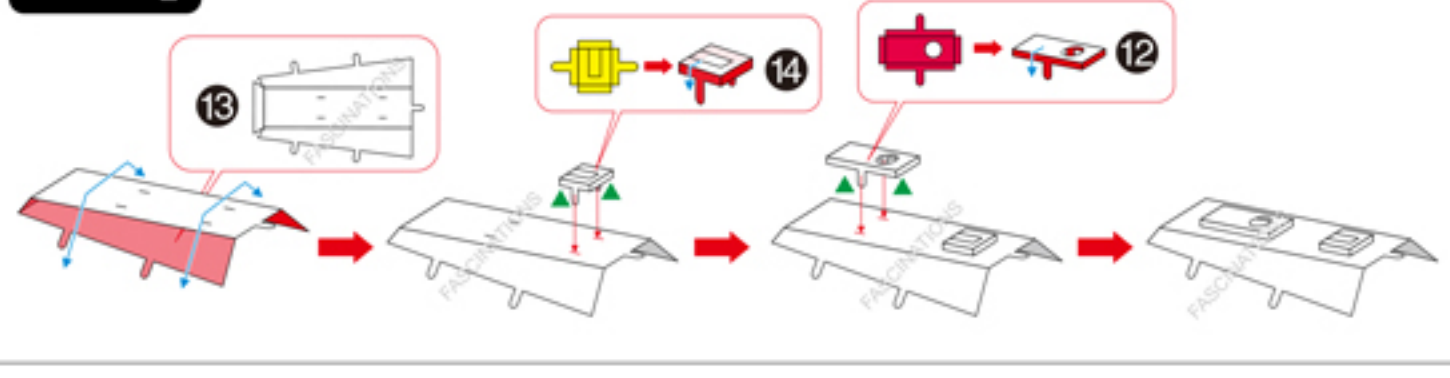

Step 5

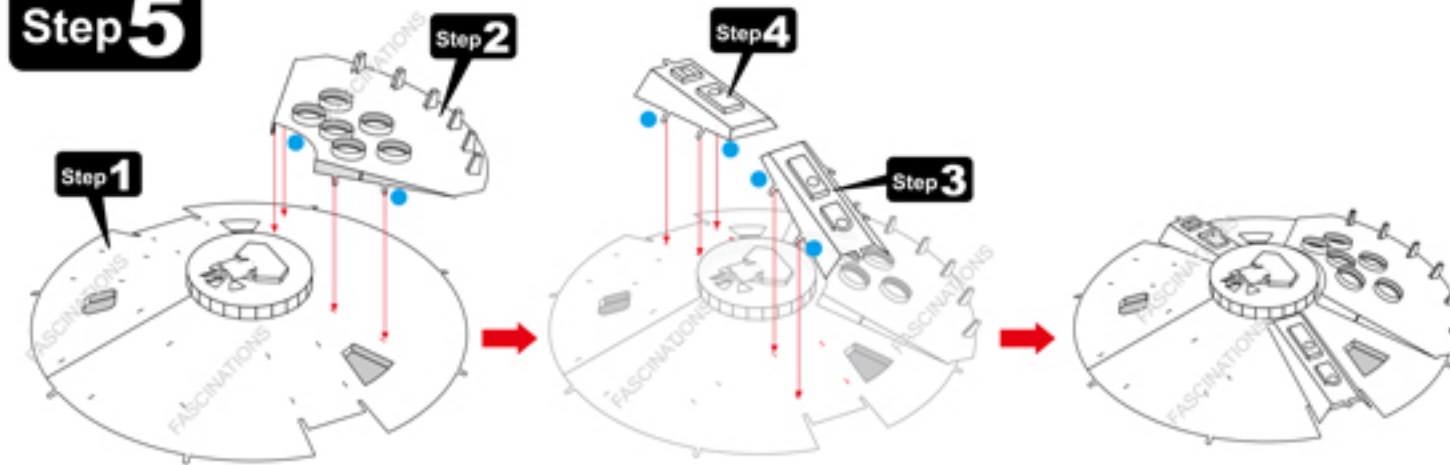

Step 6

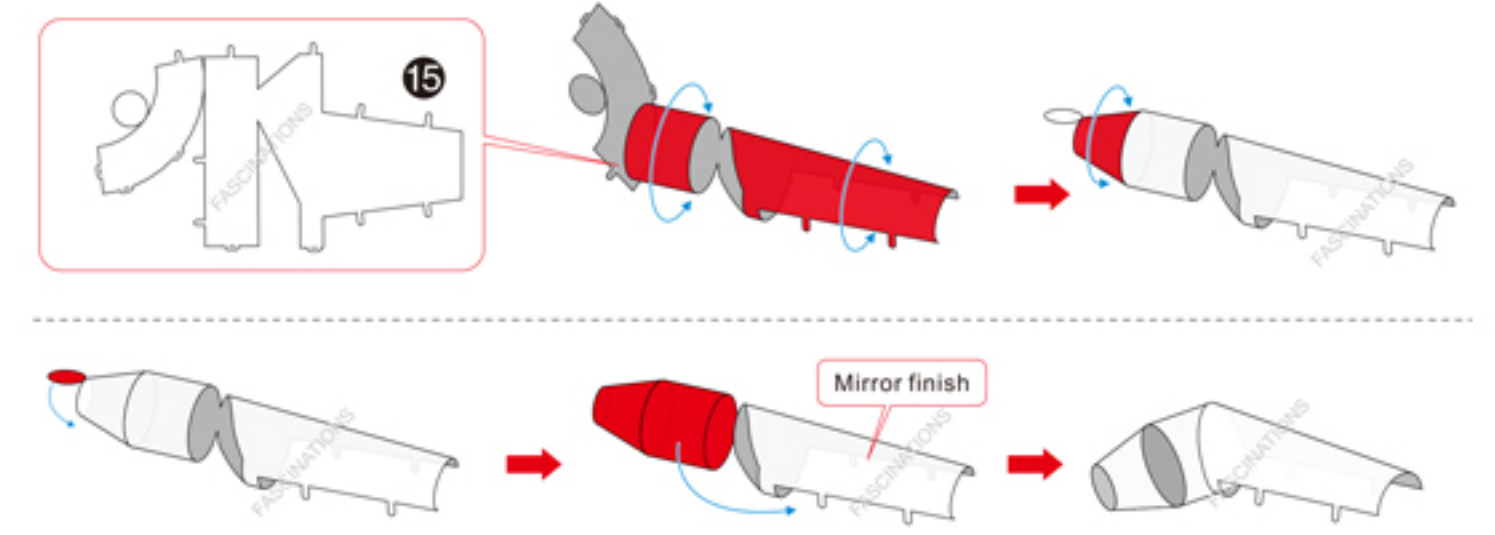

Step 7

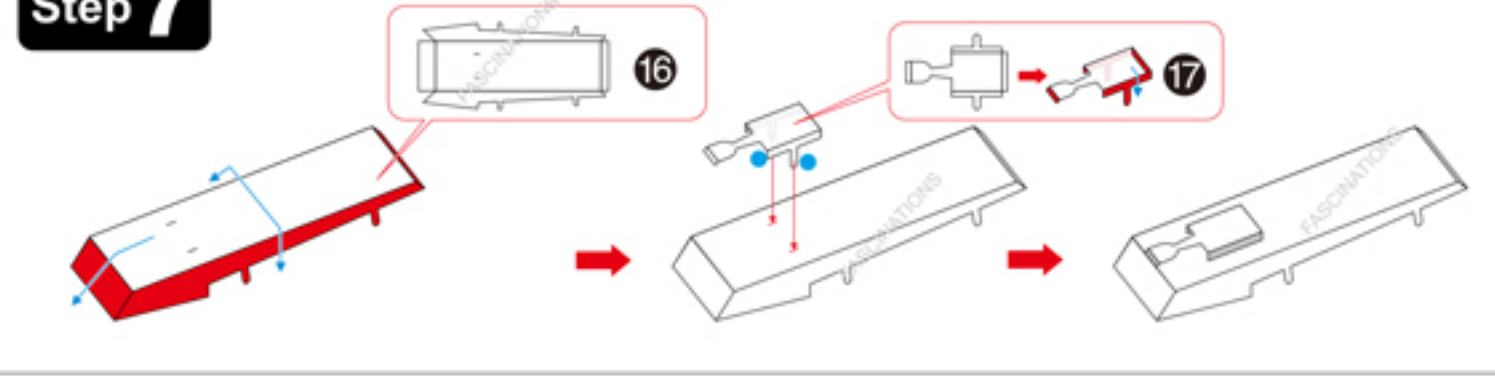

Step 8

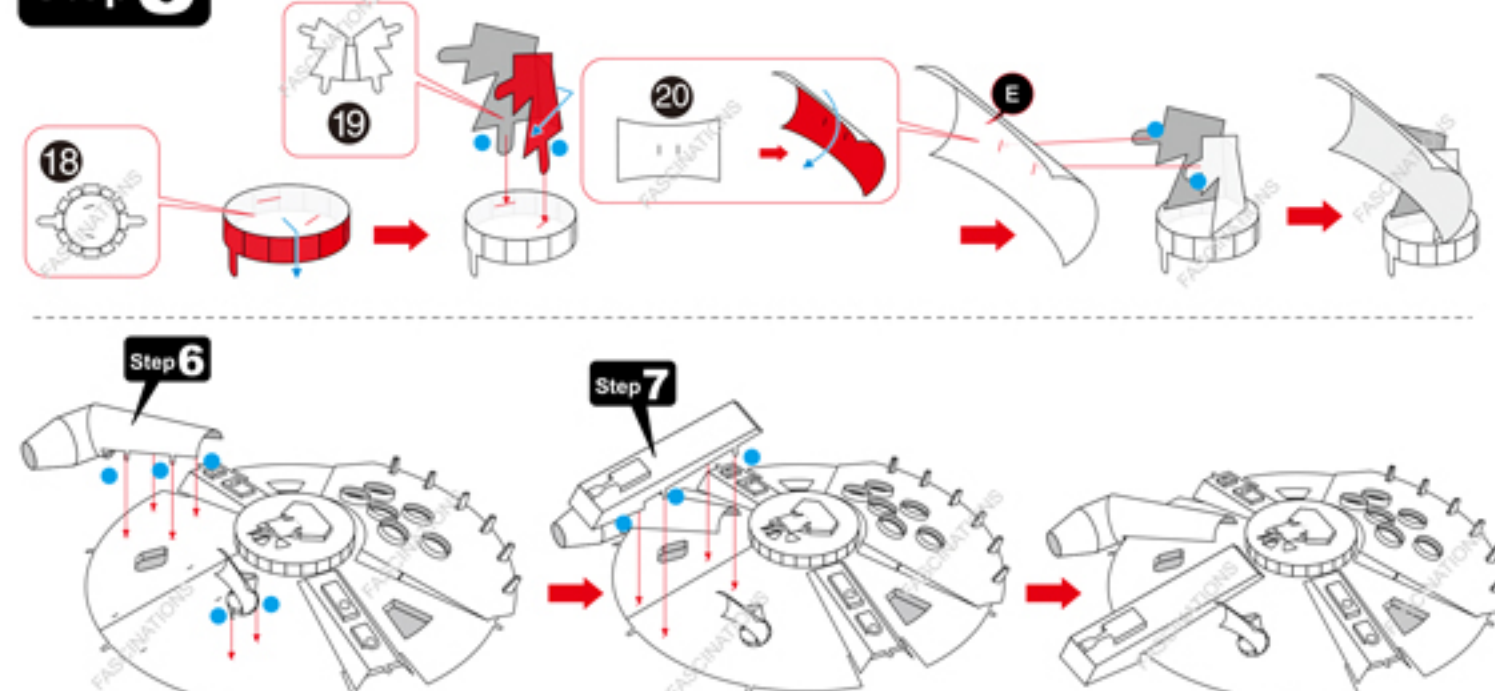

Step 9

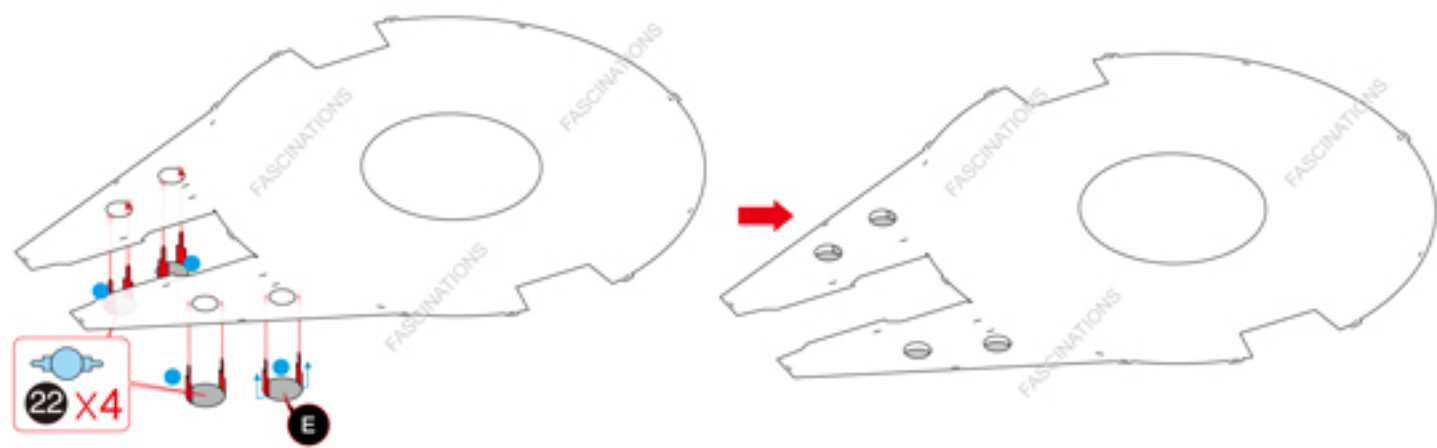
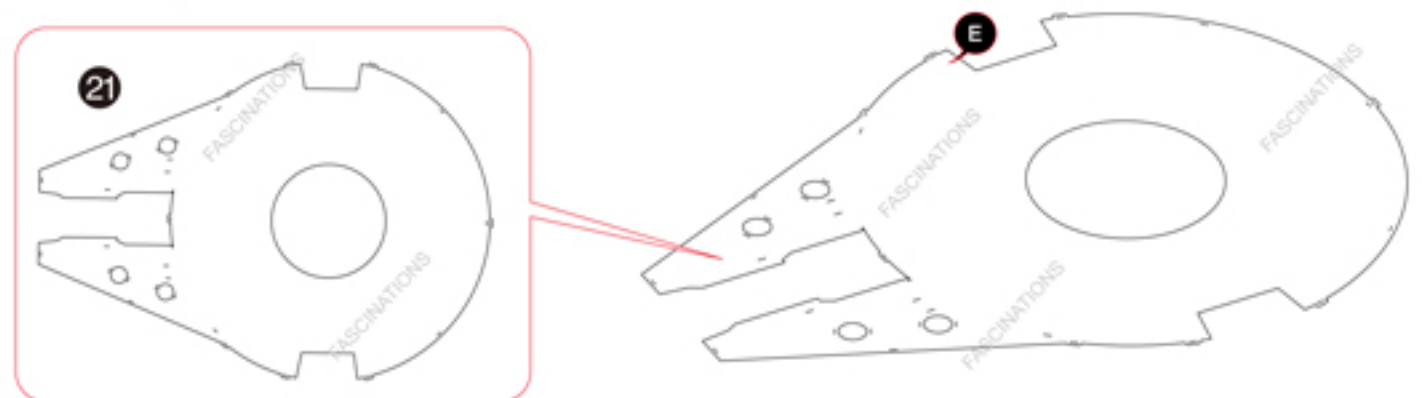

Step 10

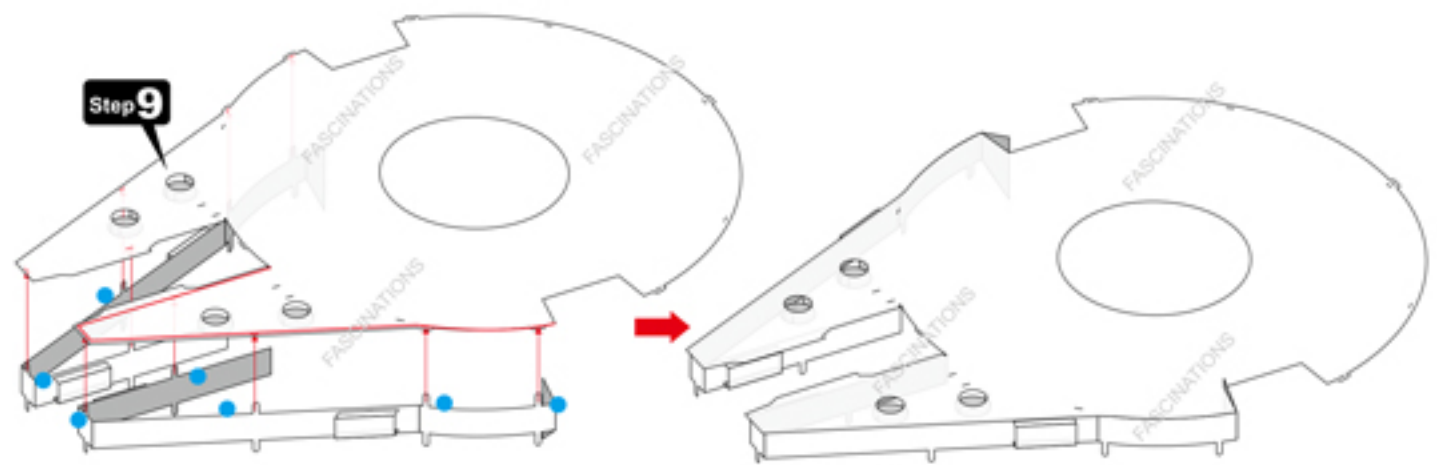
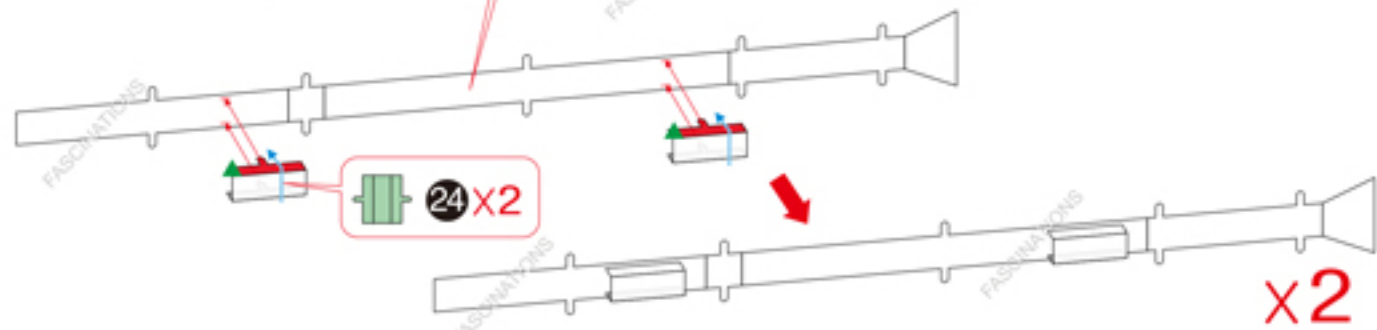
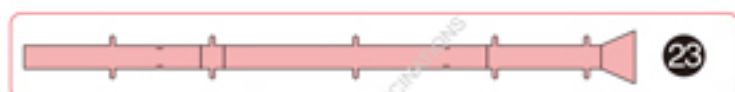

Step 11

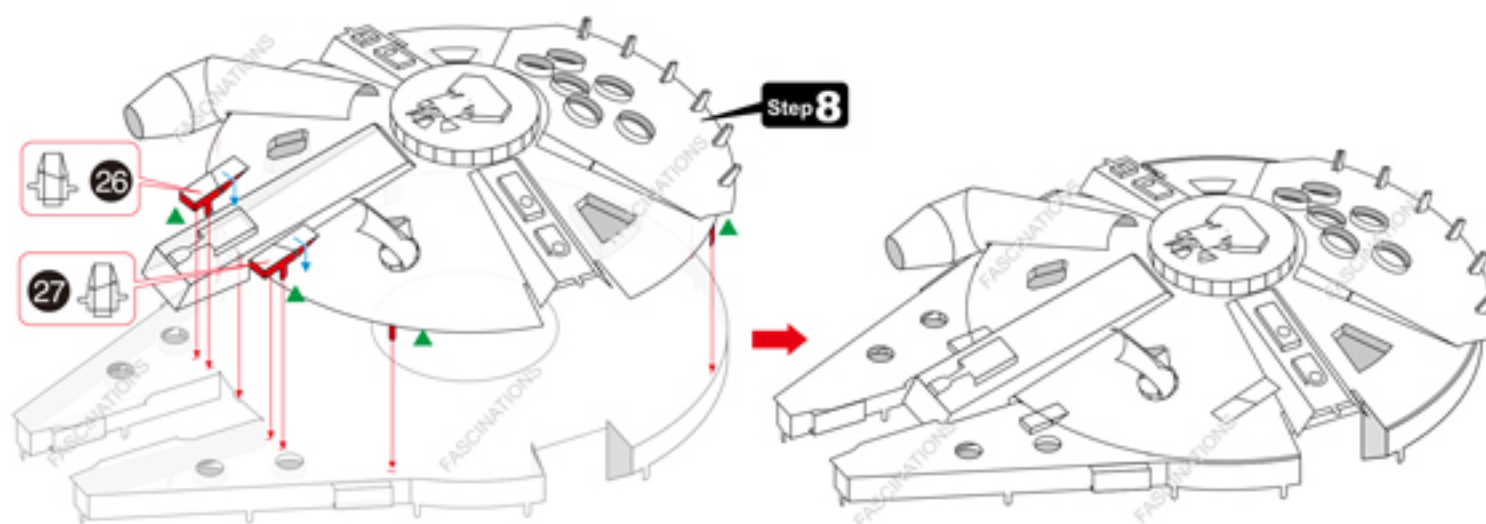
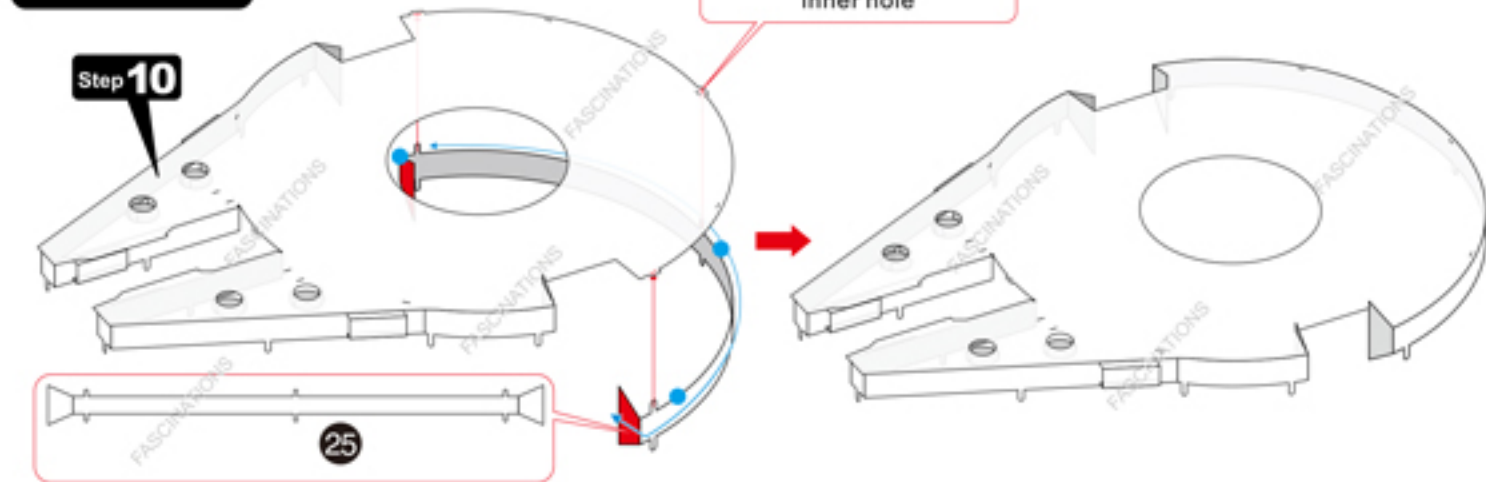

Step 12

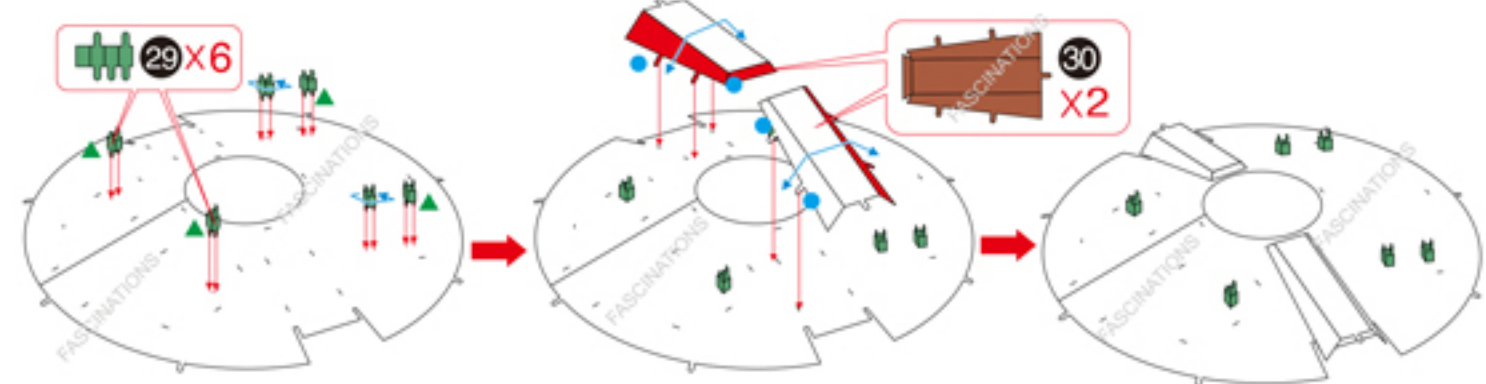
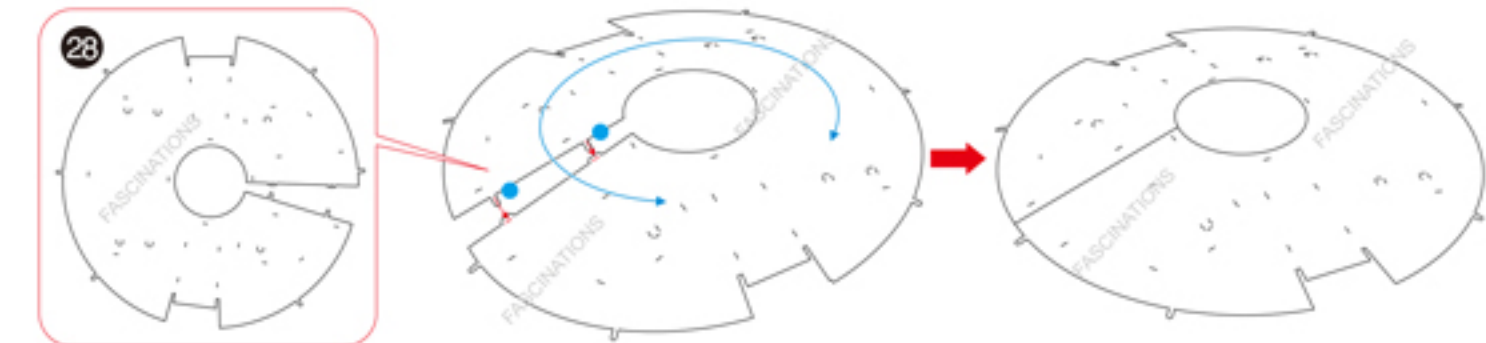

Step 13

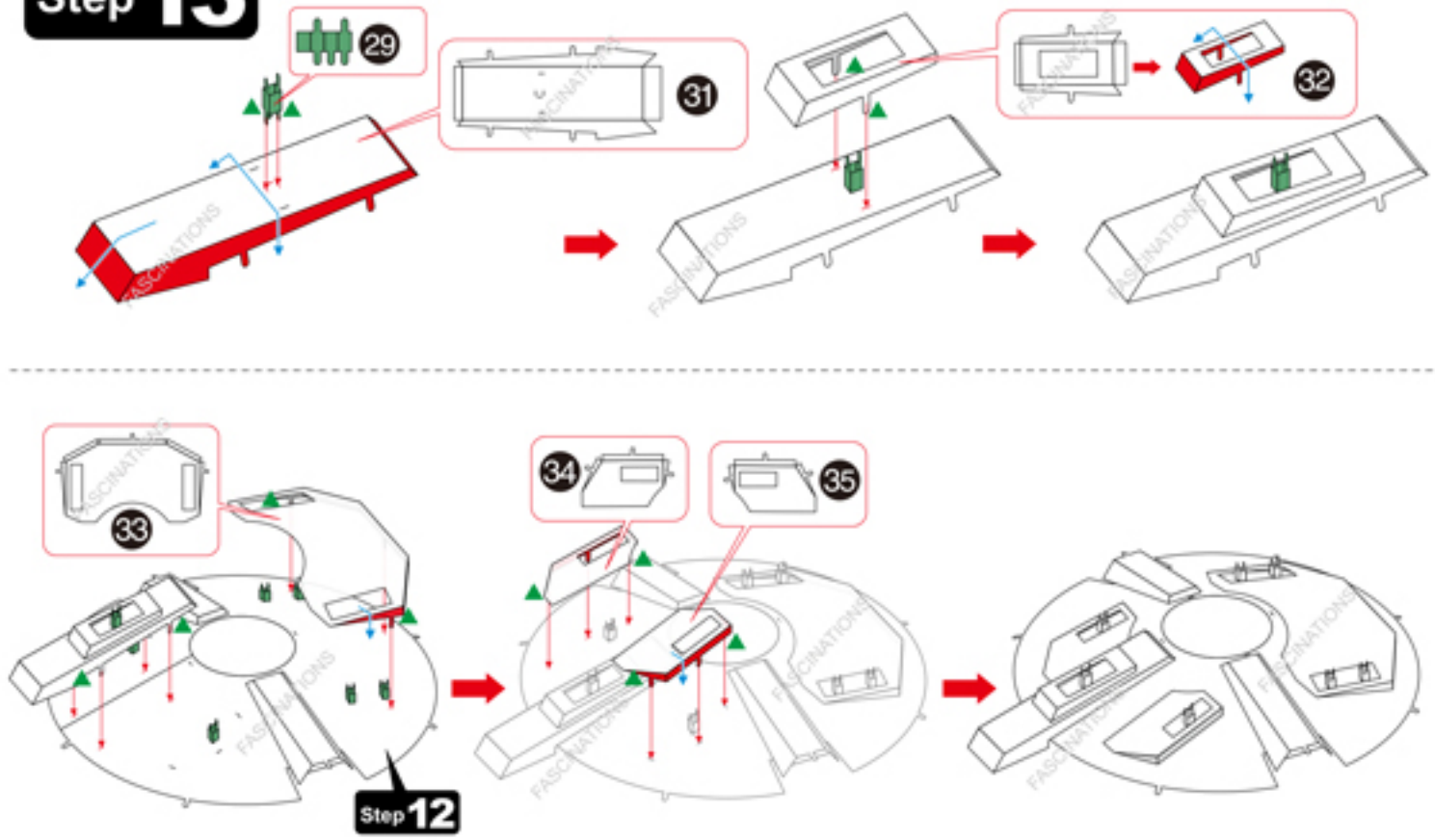

Step 14

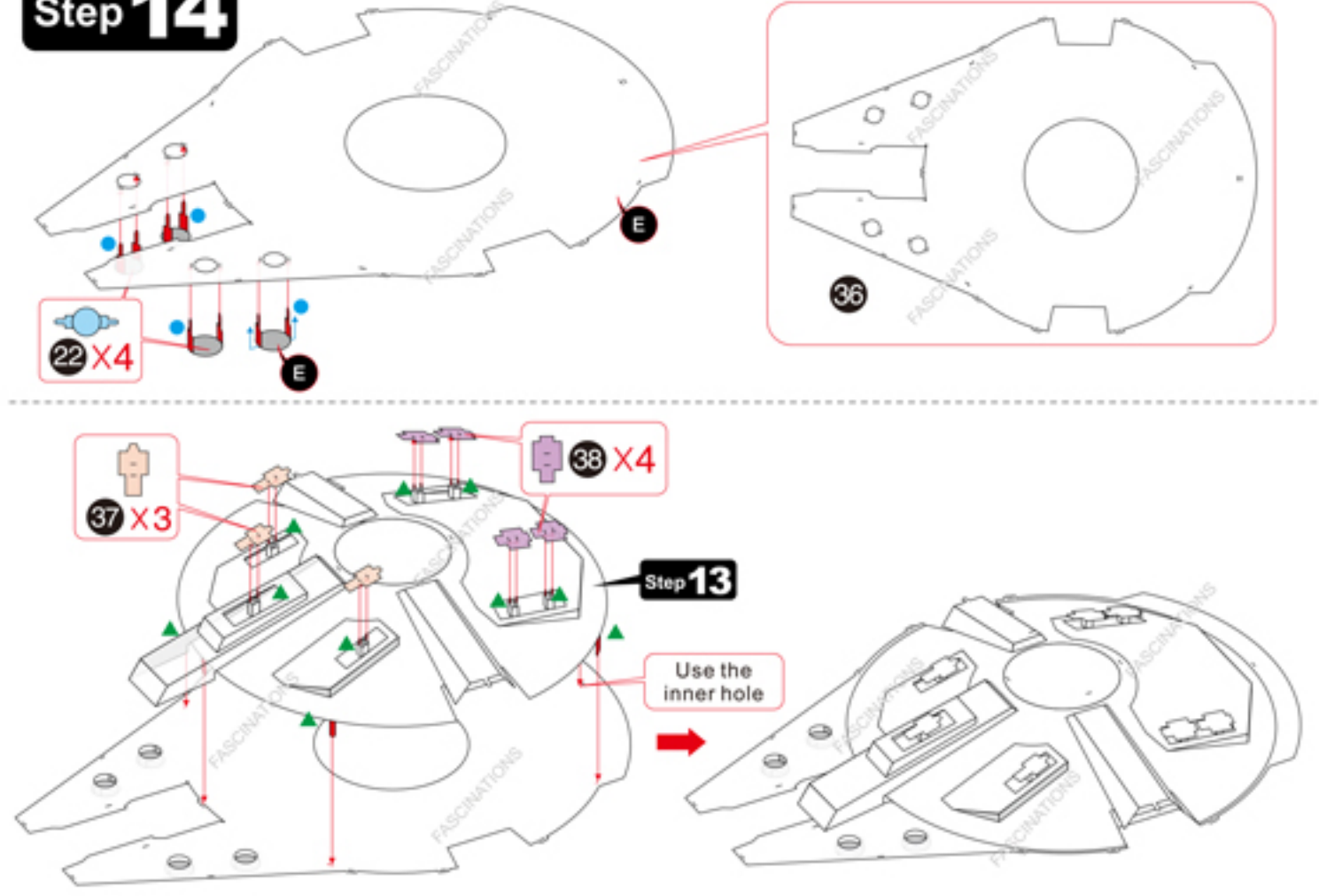

Step 15

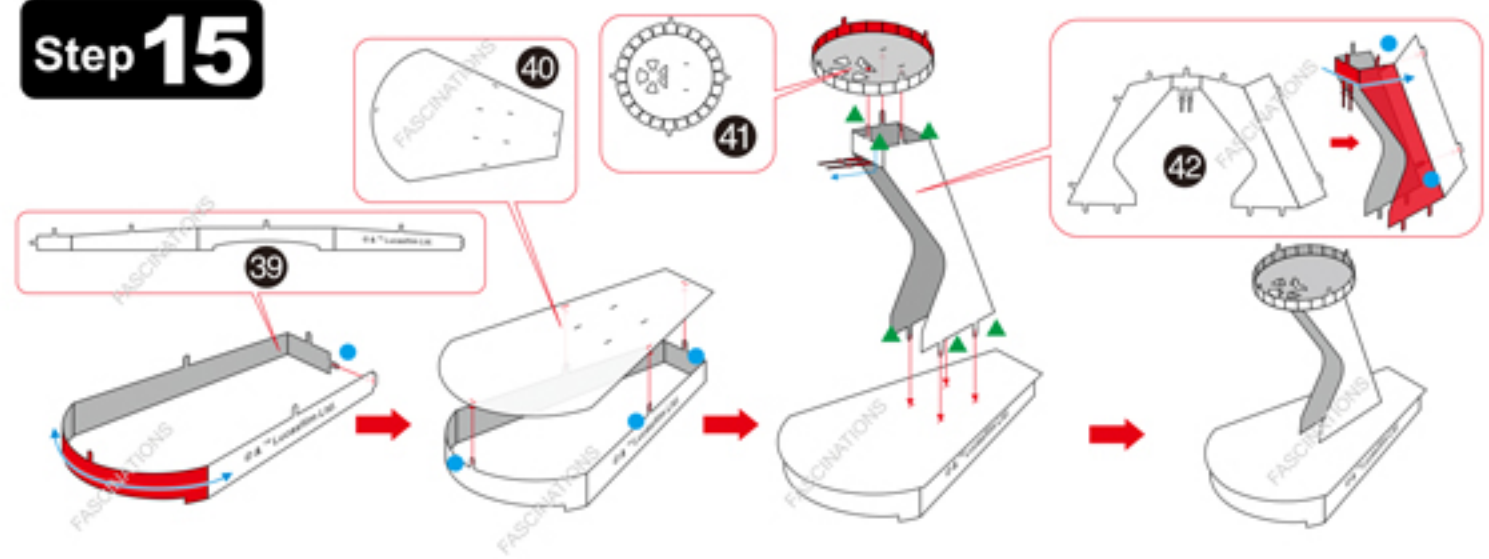

Step 16

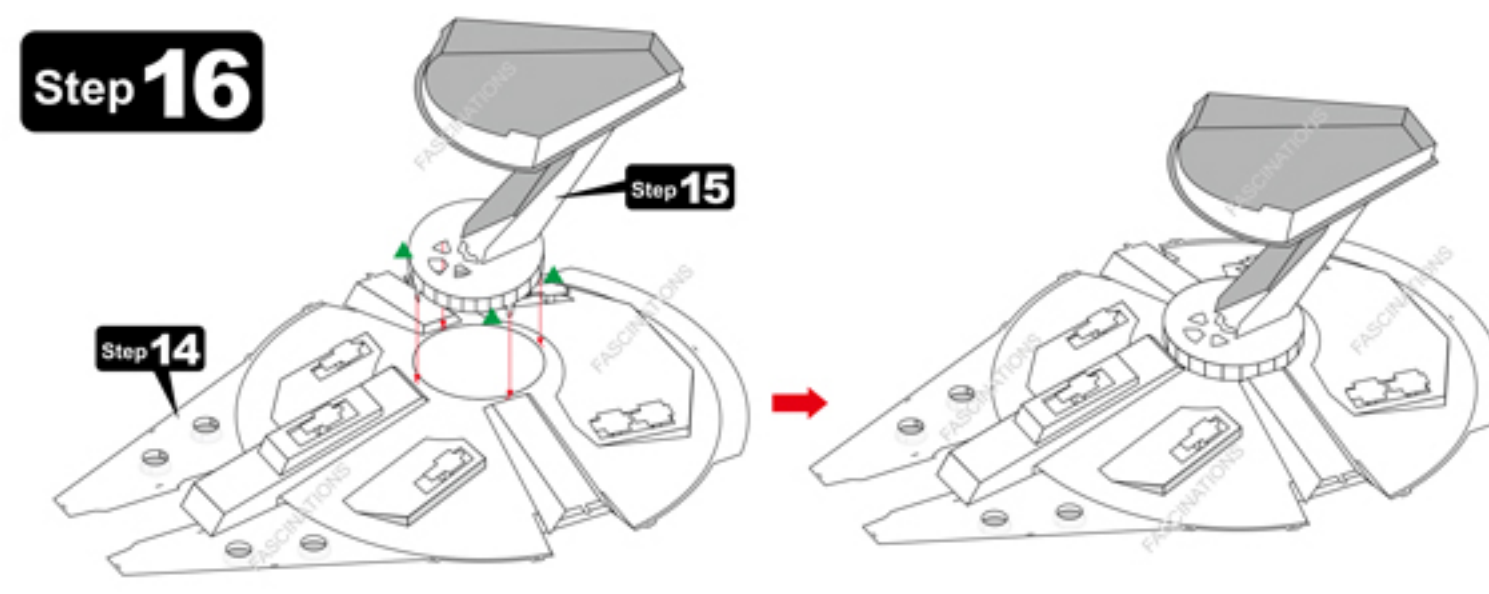

Step 17

